

#108062



## Modular Chicken Coop

### OWNER'S MANUAL



#### **WARNING:**

Read carefully and understand all **ASSEMBLY AND OPERATION INSTRUCTIONS** before operating. Failure to follow the safety rules and other basic safety precautions may result in serious personal injury.

**MODEL # YTF-700CC**

Thank you very much for choosing this product! For future reference, please complete the owner's record below:

Model: YTF-700CC Purchase Date: \_\_\_\_\_

Save the receipt, the warranty, and these instructions. It is important that you read the entire manual to become familiar with this product before you begin using it.

This product is designed for certain applications only. The manufacturer cannot be responsible for issues arising from modification. We strongly recommend that this product not be modified and/or used for any application other than that for which it was designed. If you have any questions relative to a particular application, DO NOT use the product until you have first contacted us to determine if it can, or should, be performed on the product.

For technical questions, please call 1-218-943-6290.

## TECHNICAL INFORMATION

Item	Description
Dimensions	105" x 39.4" x 67"
Construction	Fir wood
Nesting Areas	2
Roosting Bars	2
Hardware	Stainless Steel / Galvanized Steel
Mesh Construction	.8 mm wire
Chicken Capacity	6

## IMPORTANT SAFETY INFORMATION

 **WARNING:** Read and understand all instructions. Failure to follow all instructions listed below may result in serious injury.

 **CAUTION:** Do not allow persons to operate or assemble this product until they have read this manual and have developed a thorough understanding of how it works.

 **WARNING:** The warnings, cautions, and instructions discussed in this instruction manual cannot cover all possible conditions or situations that could occur. It must be understood by the operator that common sense and caution are factors that cannot be built into this product, but must be supplied by the operator.

 **DO NOT:** Allow children to play in, on, or around this product.

**SAVE THESE INSTRUCTIONS**

## WORK AREA

- Keep work area clean, free of clutter, and well-lit. Cluttered and dark work areas can cause accidents.
- Keep children and bystanders away while assembling this product.

## PERSONAL SAFETY

- Use safety apparel and equipment. Use safety glasses with side shields that comply with current national standards, while assembling this product. This applies to all persons in the work area. Also use non-skid safety shoes, hard hats, gloves, dust collection systems, and hearing protection when needed.

## CHICKEN COOP USE AND CARE

- Do not modify this product in any way. Unauthorized modification may impair the function and/or safety and could affect the life of the equipment. There are specific applications for which this product was designed.
- Always check for damaged or worn-out parts before using this product. Broken parts will affect operation. Replace or repair damaged or worn parts immediately.

## ASSEMBLY

### Step #1:

Attach the Left House Panel (A) to the Front House Panel (B) to the Rear House Panel (C) using eight Screws (1).

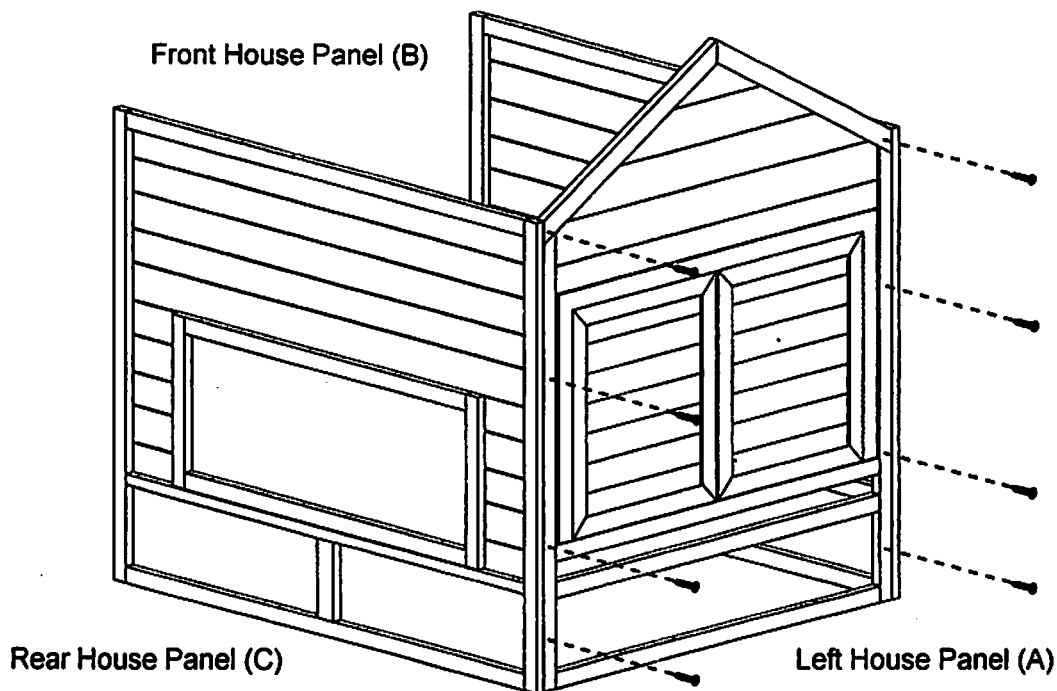

**Step #2:**

Attach the Right House Panel (D) to the Front House Panel (B) and the Rear House Panel (C) using eight Screws (1).

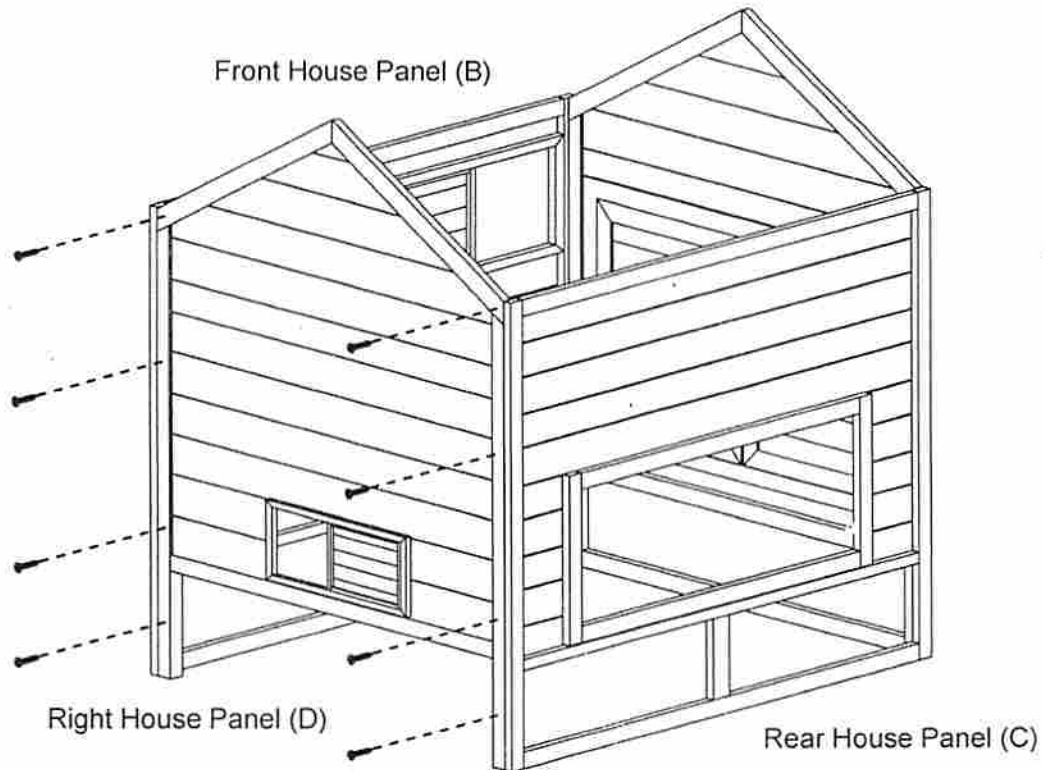

**Step #3:**

Attach the Left Nesting Box Panel (E) and the Right Nesting Box Panel (F) to the Rear House Panel (C) using four Bolts (2) and four Nuts (3).

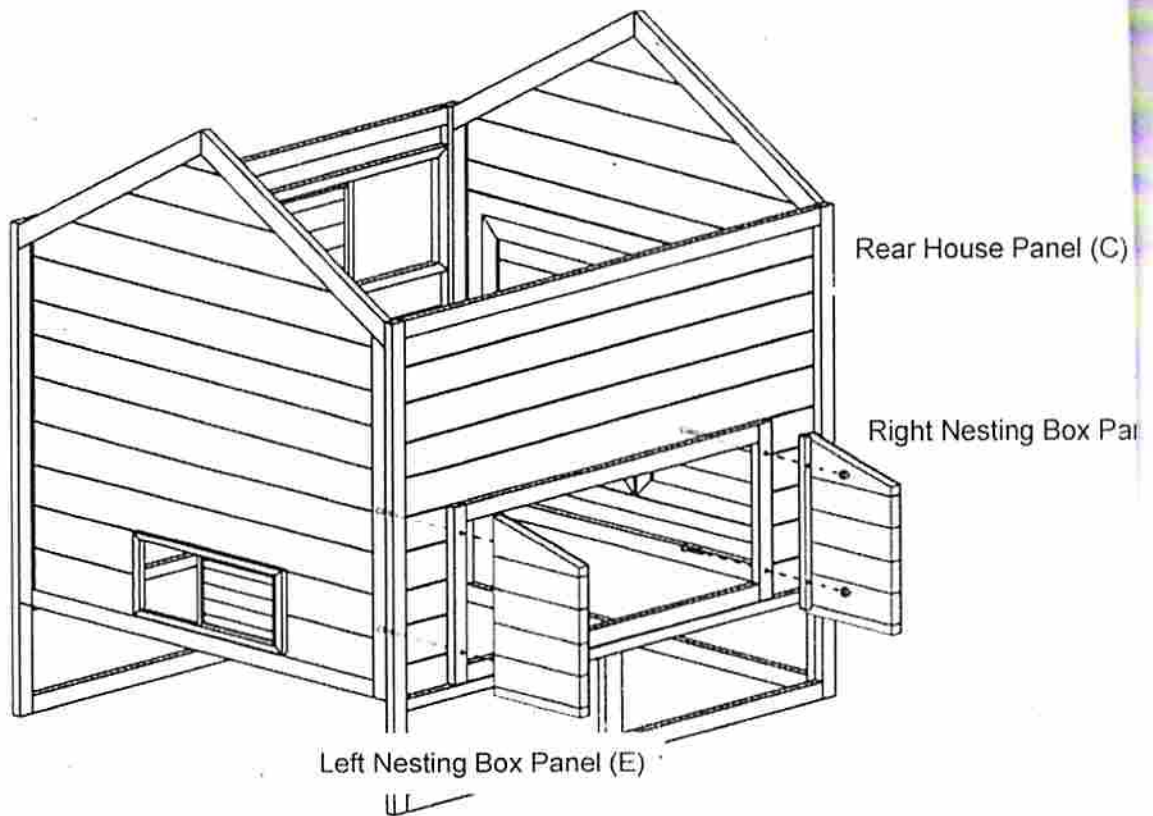

Step :  
Insert  
Screw

Note  
acro:

ight

**Step #4:**

Insert the Nesting Box Floor Panel (G) from the top. Attach the Rear Nesting Box Panel (H) using four Screws (6).

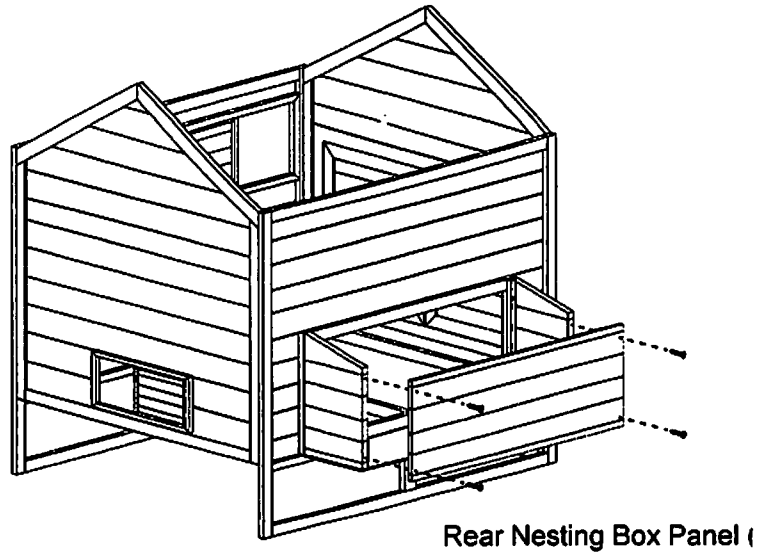
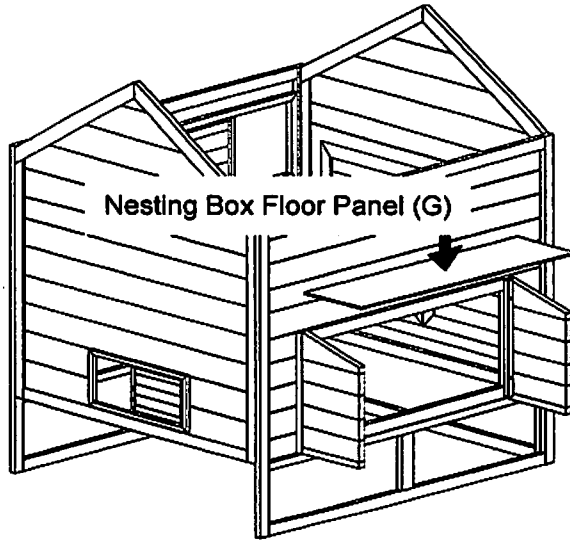

**Step #5:**

Insert the Nesting Box Partitions (I) into the slots inside the Nesting Box. Attach the Nesting Box Roof Panel (J) using four Screws (5) to fasten the two hinges.

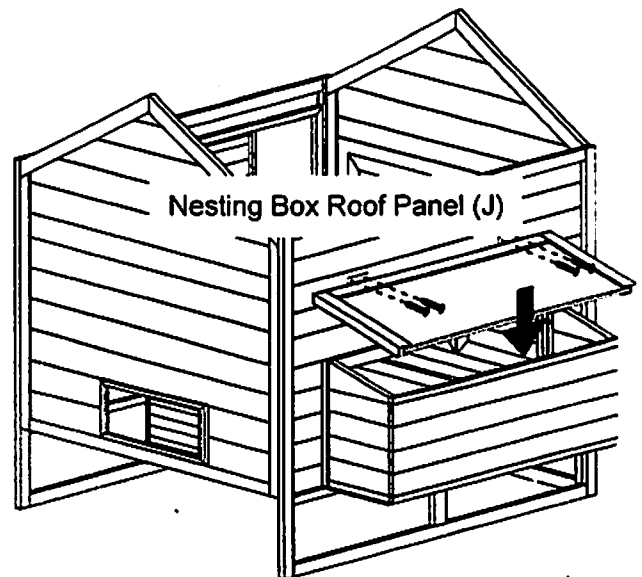
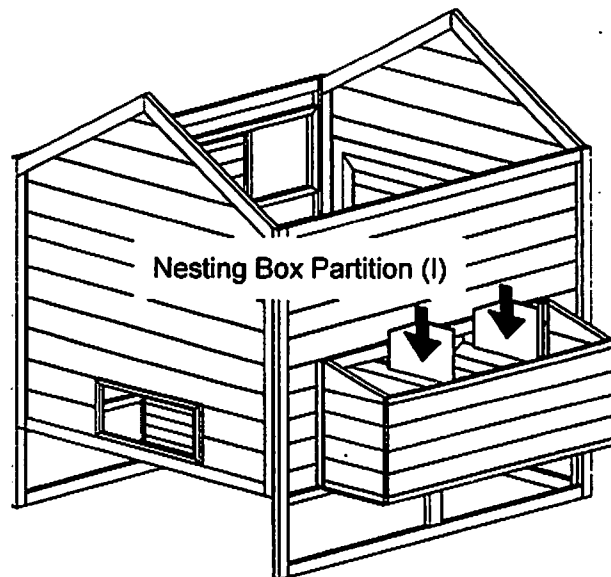

C)

Panel (C)

g Box Par

**Note: For added weatherproofing install weather strip under Nesting Box Roof Panel (J) hinges across the entire length of the Roof Panel.**

**Step #6:**

Attach the House Roof Panels (K) using eight Screws (4).

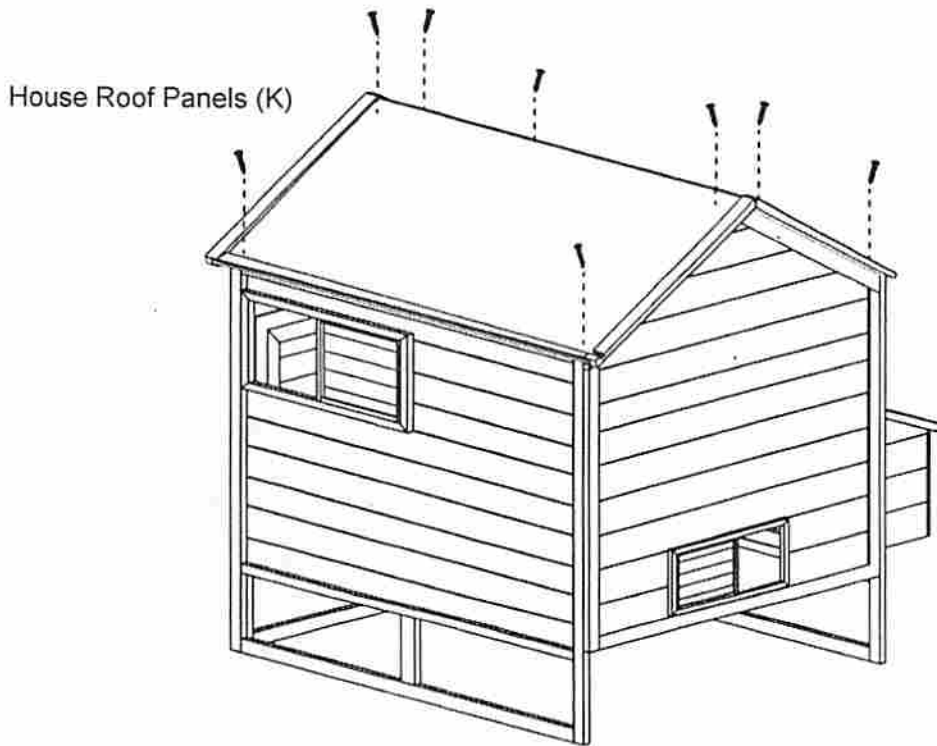

**Step #7:**

Attach the Roof Cap (L) using two Screws (4). Install the Ramp (M) by placing it onto the Right House Panel (D) door frame.

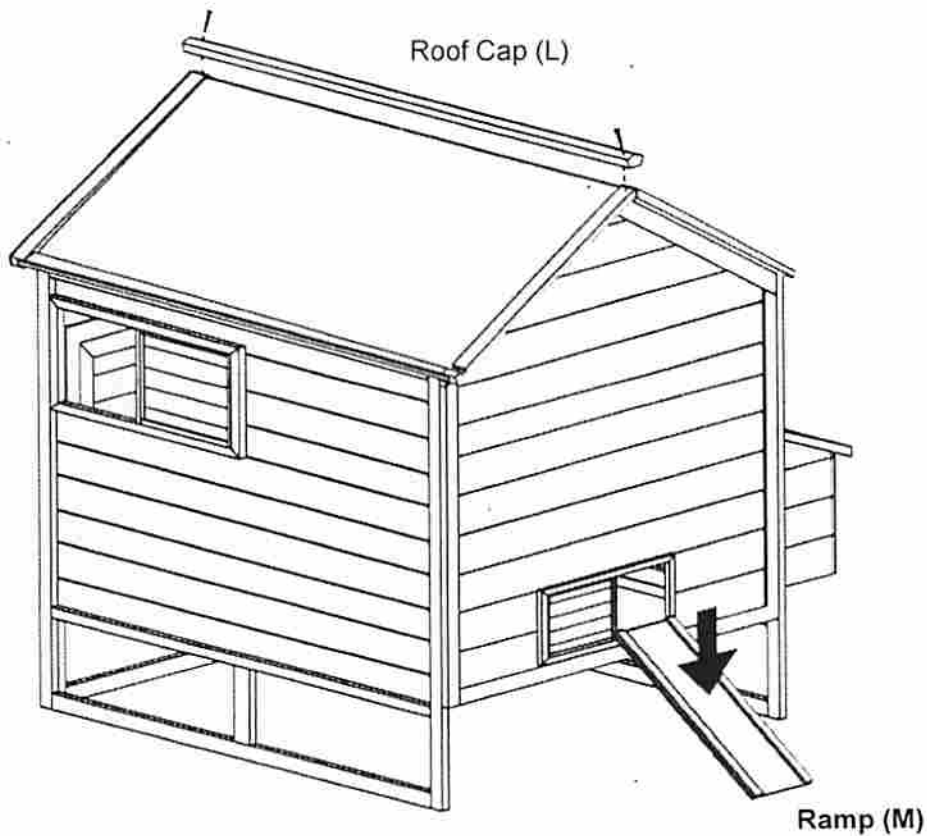

**Note:** For added weatherproofing add a bead of silicone around the base of the Roof Cap (L) where it meets the House Roof Panels (K).

**Step #8:**

Open the two Left House Panel (A) doors and install three of the Roosting Bars (N) by placing them widthwise in the slots on the inside frame.

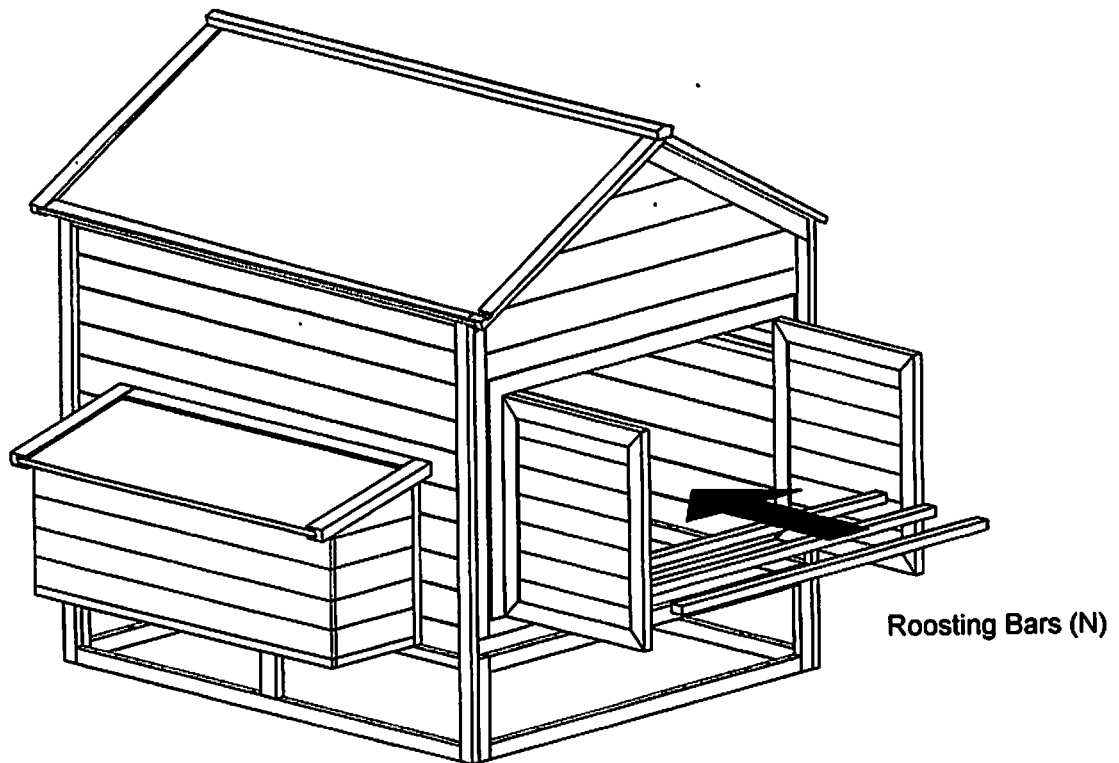

**Step #9:**

Install the Drawer Panel (O) by sliding it into the slot under the Left House Panel (A) doors.

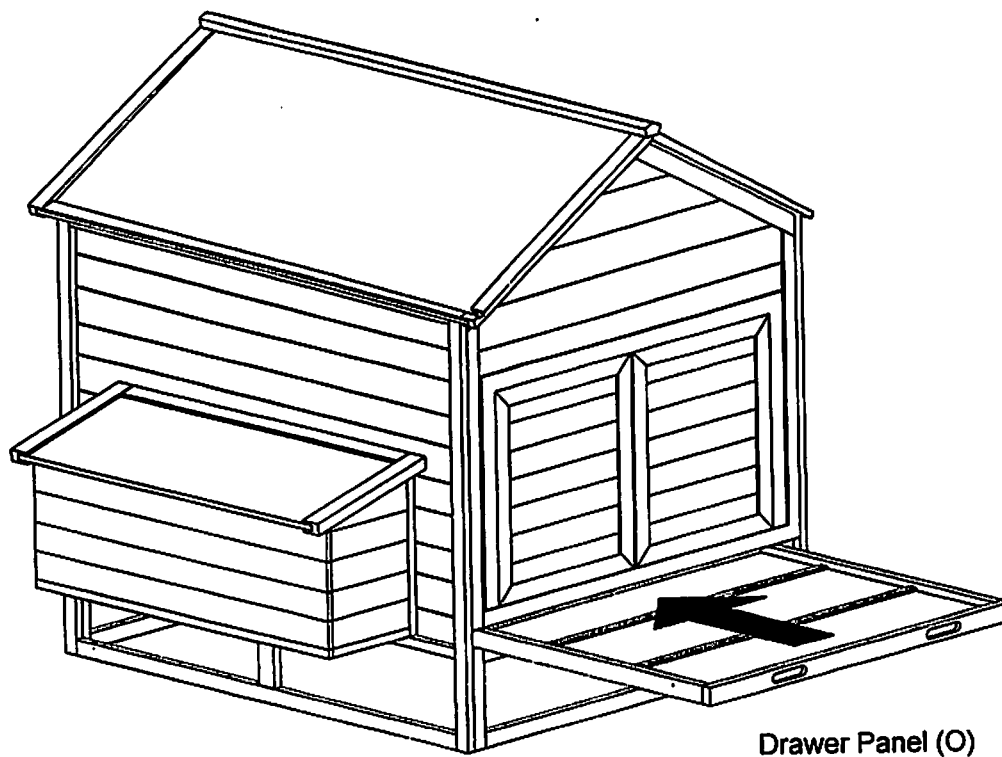

**Step #10:**

Attach the Front Pen Panel (P) and the Rear Pen Panel (Q) to the End Pen Panel (R) using six Screws (1).

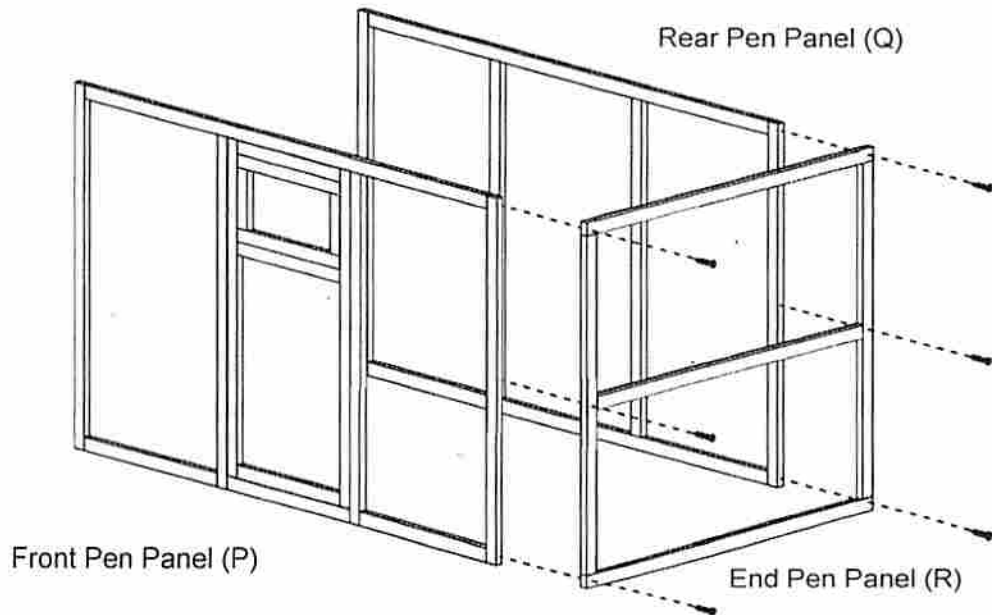

**Step #11:**

Attach the Pen to the House using six Screws (12) on both sides.

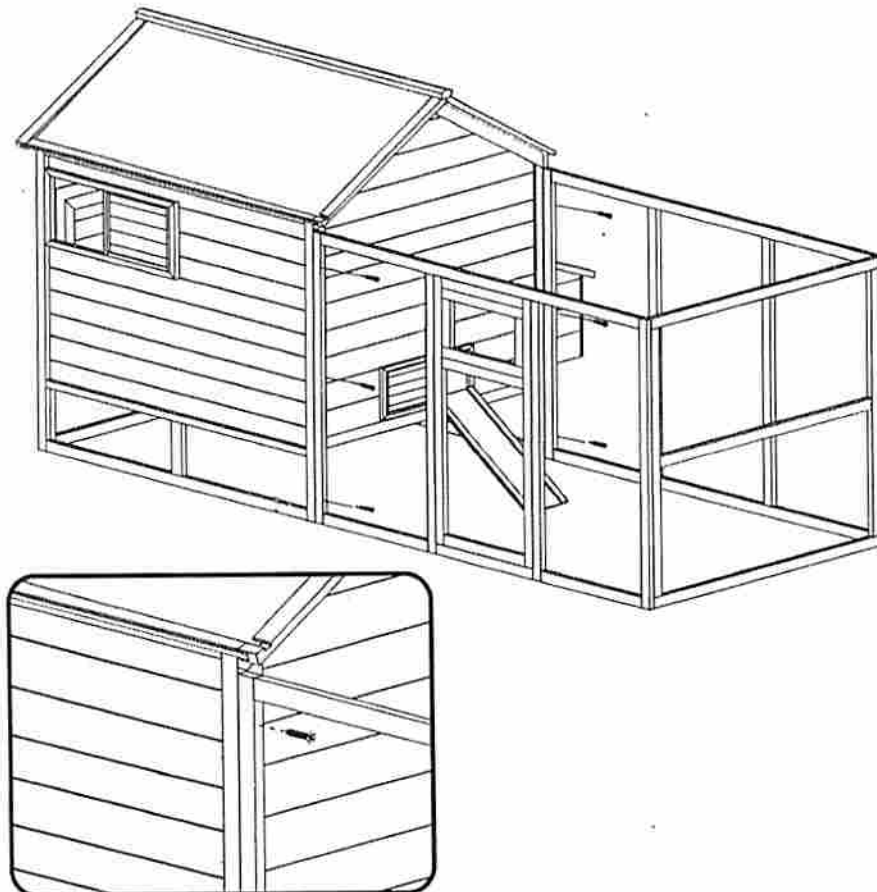



**Step #12:**

Install the four Corner Brackets (11) at each corner of the End Pen Panel (R) using eight Screws (5). Then Attach the remaining Roosting Bar (N) from the outside of the pen using two Screws (1).

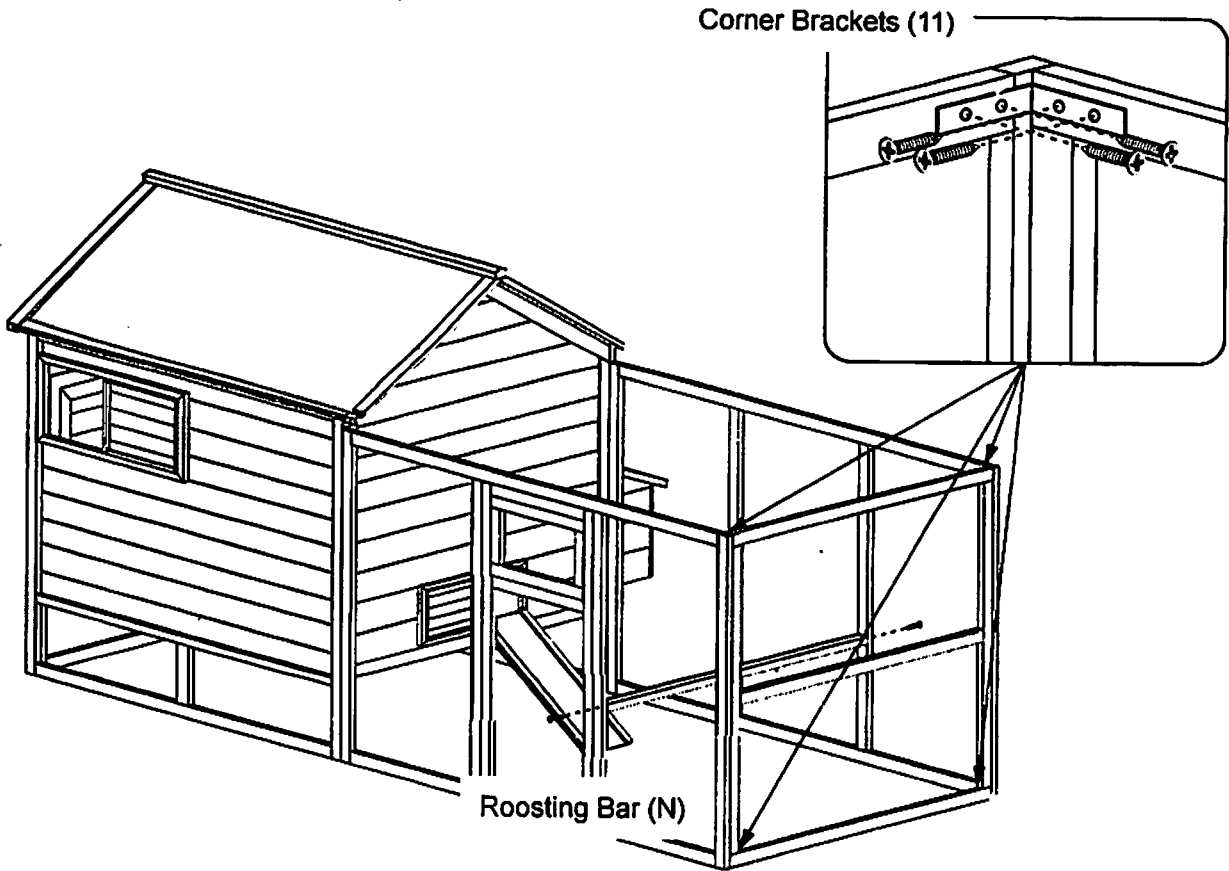

**Step #13:**

Attach the Top Pen Panel (S) using six Screws (1).

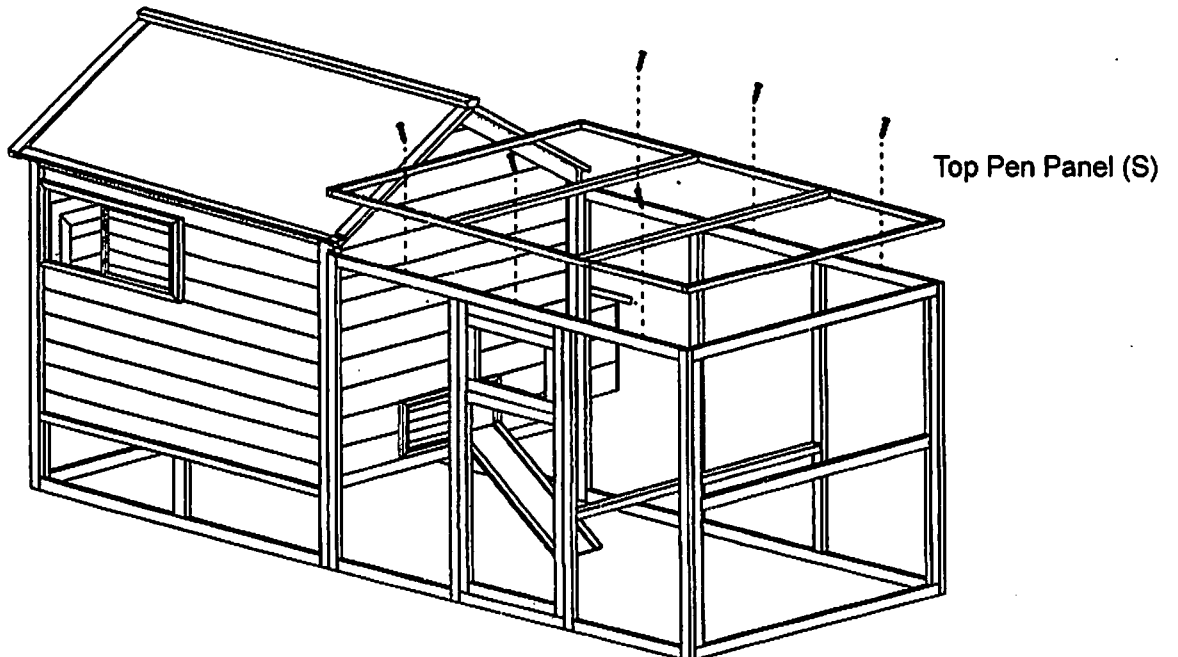

**Step #14:**

Attach the Looped Door Handle (T) to the Looped Door Handle Rod (U) using one Bolt (7) and one Nut (8).

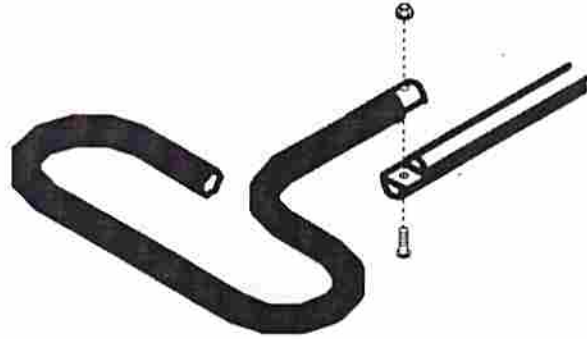

**MAINTENANCE**

- **Cleaning Instructions:** Clean with water and mild soap. Avoid harsh detergents. Dry completely.



# PARTS DIAGRAM

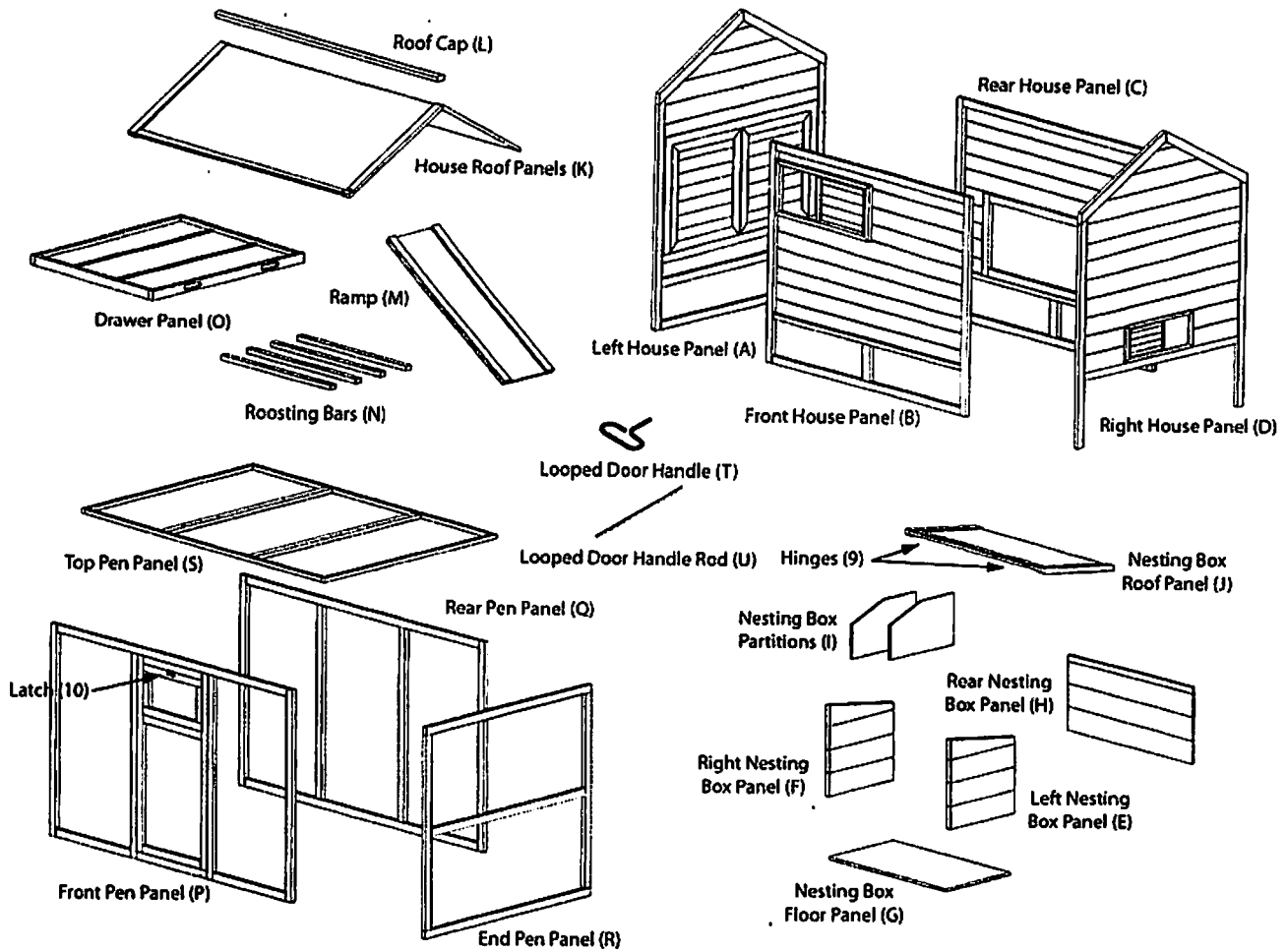

## PARTS LIST

Part #	Description	Qty.	Part #	Description	Qty.
A	Left House Panel	1	Q	Rear Pen Panel	1
B	Front House Panel	1	R	End Pen Panel	1
C	Rear House Panel	1	S	Top Pen Panel	1
D	Right House Panel	1	T	Looped Door Handle	1
E	Left Nesting Box Panel	1	U	Looped Door Handle Rod	1
F	Right Nesting Box Panel	1	1	Screw, M4 40mm	30
G	Nesting Box Floor Panel	1	2	Bolt, M6 55mm	4
H	Rear Nesting Box Panel	1	3	Nut, M6	4
I	Nesting Box Partition	2	4	Screw, M3 30mm	10
J	Nesting Box Roof Panel	1	5	Screw, M3 16mm	20
K	House Roof Panels	2	6	Screw, M4 35mm	4
L	Roof Cap	1	7	Bolt, M4 10mm	1
M	Ramp	1	8	Nut, M4	1
N	Roosting Bars	4	9	Hinges	10
O	Drawer Panel	1	10	Latch	7
P	Front Pen Panel	1	11	Corner Bracket	4
			12	Screw, M4 50mm	6